

Patio Table

PROJECT PLAN

YellaWood
Pressure Treated Pine



Do your down time right.

A patio table adds sophistication and charm to an outdoor space. It anchors the seating elements and provides a surface for food, drinks, and plants.

This table has been designed with simplicity and elegance in mind. It features a strong and sleek base with cladding that waterfalls from the top surface down the front and back sides. Using 4x4s as legs, 2x4s for structure, and 1x4s for cladding, this project takes shape in just a few steps.

When the leg assemblies are completed, the support structure is secured to create the table's skeleton. From there, it's just a matter of attaching the slats that waterfall over the front and back sides.

After a light sanding and a water-proof finish is applied, you and your family will be set to enjoy some R&R on your new patio table.

BUILD TIME

3
HRS

DIFFICULTY



COST



Patio Table

IMPORTANT REMINDERS

- **Read instructions** to familiarize yourself with the entire process before beginning.
- **Always double check measurements** before making cuts - Great Southern Wood is not responsible for incorrect cuts.
- **Select and use the best faces** of boards on the outside of assemblies
- **Pre-drill** holes before attaching screws. Set $\frac{1}{8}$ " drill bit inside combination countersink bit to appropriate depth for each screw length called for.
- **Wood glue is optional:** if you choose to use it, apply to surfaces before attaching parts, and be sure to wipe up excess with a damp cloth.
- **Check BuildYella.com for updates** to plans and to view the video of this project.

Because wood stock can vary, dry-fit sub-assemblies as needed to ensure dependent parts align. Make any adjustments needed to part dimensions before final assembly.

The Cut List is based on the following actual dimensions for board stock:

1x6	$\frac{3}{4}$ " x 5 $\frac{1}{2}$ "
1x2	$\frac{3}{4}$ " x 1 $\frac{1}{2}$ "
2x2	1 $\frac{1}{2}$ " x 1 $\frac{1}{2}$ "
2x4	1 $\frac{3}{8}$ " x 3 $\frac{1}{4}$ "
1x4	$\frac{3}{4}$ " x 3 $\frac{1}{2}$ "
1x8	$\frac{3}{4}$ " x 7 $\frac{1}{4}$ "
2x6	1 $\frac{3}{8}$ " x 5 $\frac{1}{4}$ "
$\frac{5}{4}$ x6	$\frac{7}{8}$ " x 5 $\frac{1}{4}$ "
2x10	1 $\frac{1}{2}$ " x 9 $\frac{1}{8}$ "
4x4	3 $\frac{1}{4}$ " x 3 $\frac{1}{4}$ "

Patio Table

OVERALL SIZE

YellaWood
Pressure Treated Pine

TOP

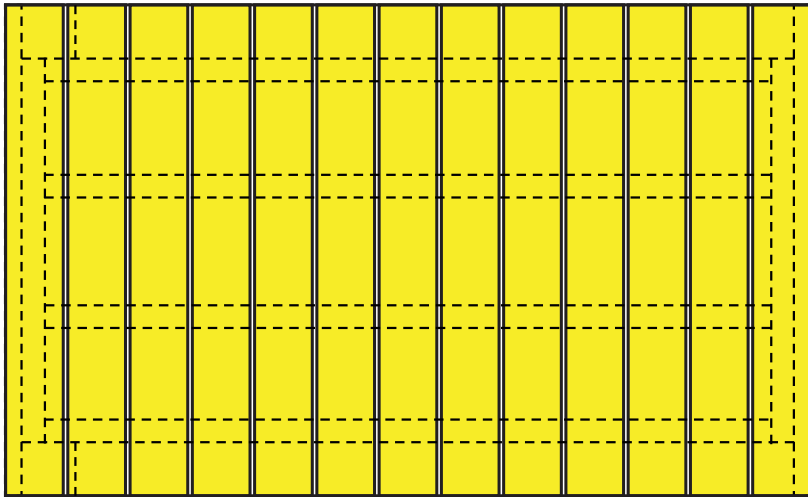

30"

48 1/2"

SIDE

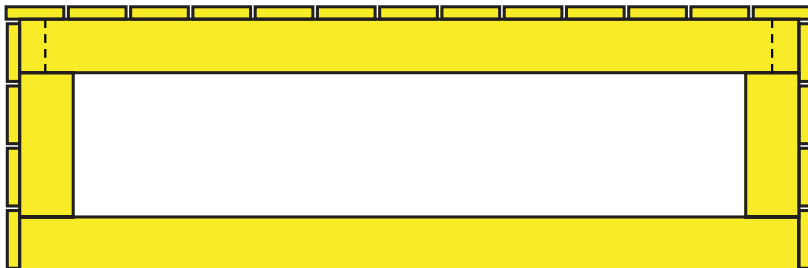

FRONT

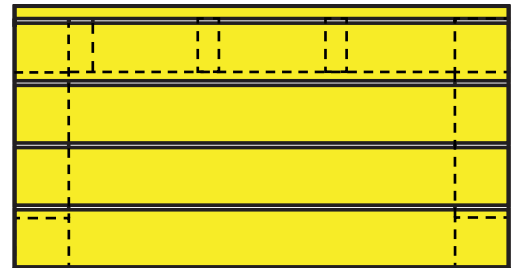

16"

Patio Table

OVERVIEW OF STEPS

YellaWood
Pressure Treated Pine

SEQUENCE OF BUILD

1: LEG ASSEMBLIES

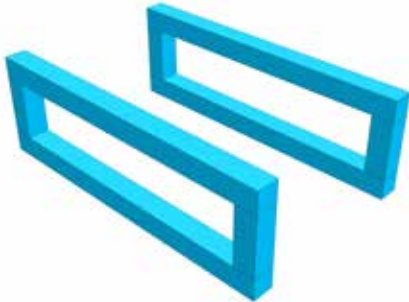

2: SUPPORT FRAME

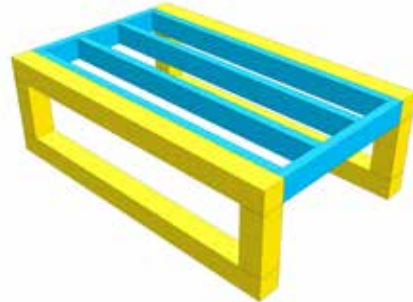

3: CLADDING

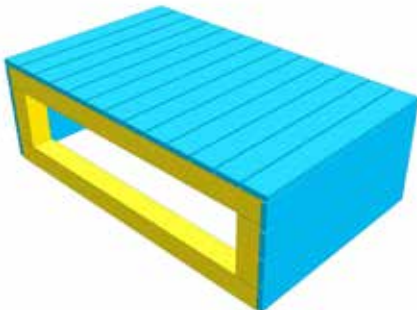

4: FINISHING



BUILD TIME

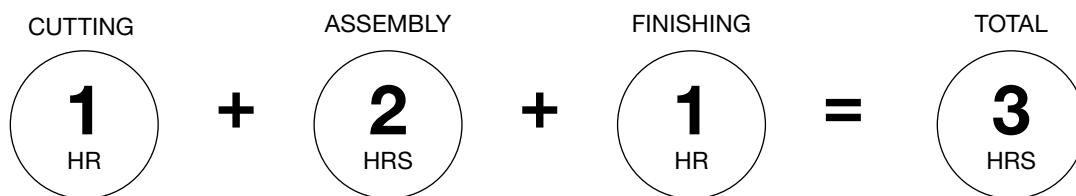

Patio Table

WHAT YOU'LL NEED

YellaWood®
Pressure Treated Pine

MATERIALS

- 2x** 4x4x10' YellaWood® pressure treated pine
- 3x** 2x4x10' YellaWood® pressure treated pine
- 12x** 1x4x10' YellaWood® pressure treated pine

HARDWARE

½ LB BOX

- 2 ½" wood screws + appropriate bit

1 BOX (approx. 50 screws)

- 4" Heavy Duty lag wood screws (check size of head to determine hex driver)*

WOOD FINISHING

- YellaWood Protector® Stain & Sealer

TOOLS



Pencil



Measuring tape



Miter saw (or chop saw)



Table saw



Drill / driver



Drill bit (to pre-drill for lag screw: check diameter*)



½" Forstner bit (for countersinking lag screw head*)



Hex driver bit (that fits lag screw head*)



Clamps (one at least 12" long and one at least 4' long for Step 2)

SAFETY EQUIPMENT

- Work gloves
- Dust mask
- Safety glasses
- Ear protection

Notes:

Consider using YellaWood® KDAT and higher grade products to achieve more professional results.

Choose boards with minimal irregularity to get the most out of the stock. Page 6 shows maximum parts per board. If unsure about board quality, purchase 1 extra piece of each board type.

If you'd like to construct the HACK version of this plan, skip ahead to Page 15 and add one extra 1x4x10' board to your purchase list.



Square



Combination countersink bit (with 2" long ⅛" bit)



Radial sander (or sanding block)



Damp cloth (optional)



Waterproof wood glue (optional)



Paint/Stain Brush

Patio Table

CROSS-CUT DIAGRAMS



PREP: CROSS-CUT ALL PARTS

Proceed to cut all parts listed above unless noted otherwise.
Be sure **label all parts** so you know which ones to use for the Assembly Steps that follow.



CROSS-CUT TO	PART	#
47"	A	4x
8 3/4"	B	4x

4x4x10' STOCK - LEG ASSEMBLY 2 BOARDS



CROSS-CUT TO	PART	#
23 1/2"	C	2x
44 1/4"	D	4x

2x4x10' STOCK - SUPPORT FRAME 3 BOARDS

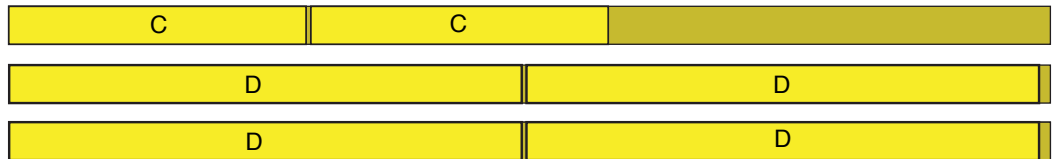

CROSS-CUT TO	PART	#
30"	E	21x

1x4x10' STOCK - CLADDING 7 BOARDS

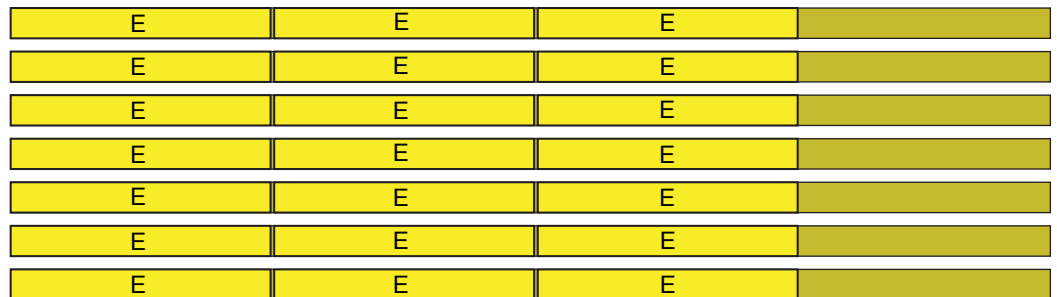

RIP-CUT TO	PART	#
TBD (See Step 11)	Spacer Jig	1x

2x4x8' STOCK SCRAP PIECE



Cut this piece **after** you've reached Section 2. Step 11 will explain how to reach the dimension needed.

Patio Table

ASSEMBLY

YellaWood
Pressure Treated Pine

SECTION 1: LEG ASSEMBLIES

TOOLS



Drill / driver



Pencil



Square



Clamps



Drill bit
(to pre-drill for
lag screw: check
diameter)



Hex driver bit
(that fits lag screw
head)



1/2" Forstner bit
(for countersinking
lag screw head)

SUPPLIES



4" Lag
screws

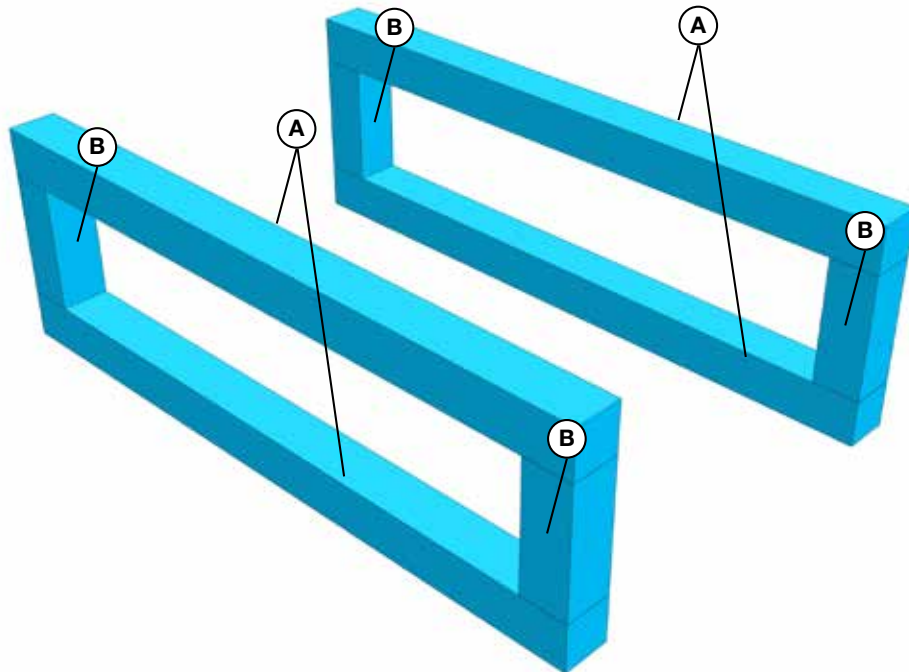

Patio Table

ASSEMBLY

YellaWood
Pressure Treated Pine

SECTION 1: LEG ASSEMBLIES

1



Begin by marking where the 2 diagonal screws will be placed on Parts (A). Use a square to make two diagonal lines, then measure and mark 1 1/4" from the edges. Do this on both sides and on other Part (A)s.

2



Lay out two Part (A)s and two Part (B)s to form a square, facing the marks you made toward you. Secure with a clamp. Use the forstner bit to countersink the depth of the head of the lag screws.

3



Using the point left by the forstner bit, continue drilling to pre-drill for the lag screw length.

4



Secure Part (A) to Part (B) with two lag screws. Repeat this procedure until you have 2 completed Leg Assemblies.

COMPLETED SECTION

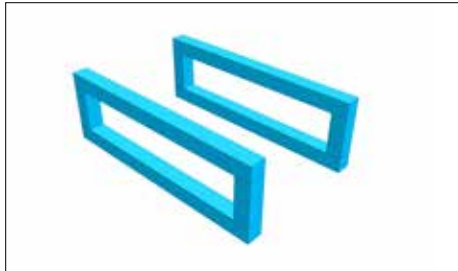

Patio Table

ASSEMBLY

YellaWood
Pressure Treated Pine

SECTION 2: SUPPORT FRAME

TOOLS



Drill / driver



Pencil



Measuring
tape

SUPPLIES



2 1/2" screws

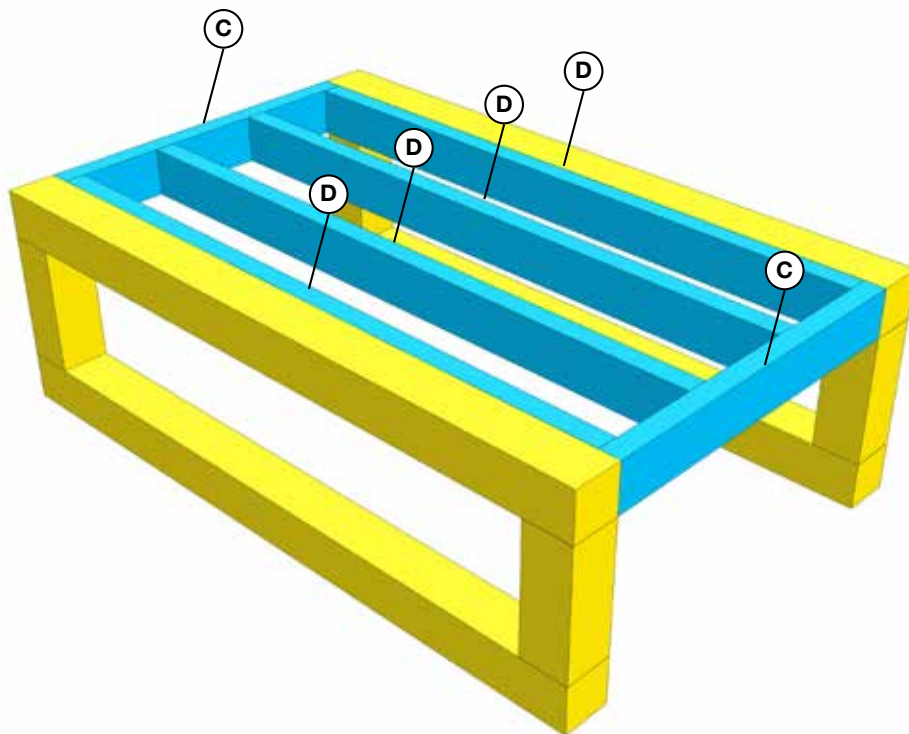

Patio Table

ASSEMBLY

YellaWood
Pressure Treated Pine

SECTION 2: SUPPORT FRAME

5



Attaching the Support Frame is best done upside down, as the work surface ensures the top of the table will be level. Lay out Parts (C) and the outside Parts (D) to fit within the Leg Assemblies.

6



Attach Part (D) to Part (A) using 2 1/2" screws. One screw placed every 8 - 10" is recommended. Repeat this on the other side.

7



Place the two remaining Part (D)s evenly spaced within the frame. Attach to one end - Part (C) - using two 2 1/2" screws.

8



Secure the other ends of (D), and your Support Frame is complete.

COMPLETED SECTION



Patio Table

ASSEMBLY

YellaWood
Pressure Treated Pine

SECTION 3: CLADDING

TOOLS



Drill / driver



Measuring
tape



Pencil

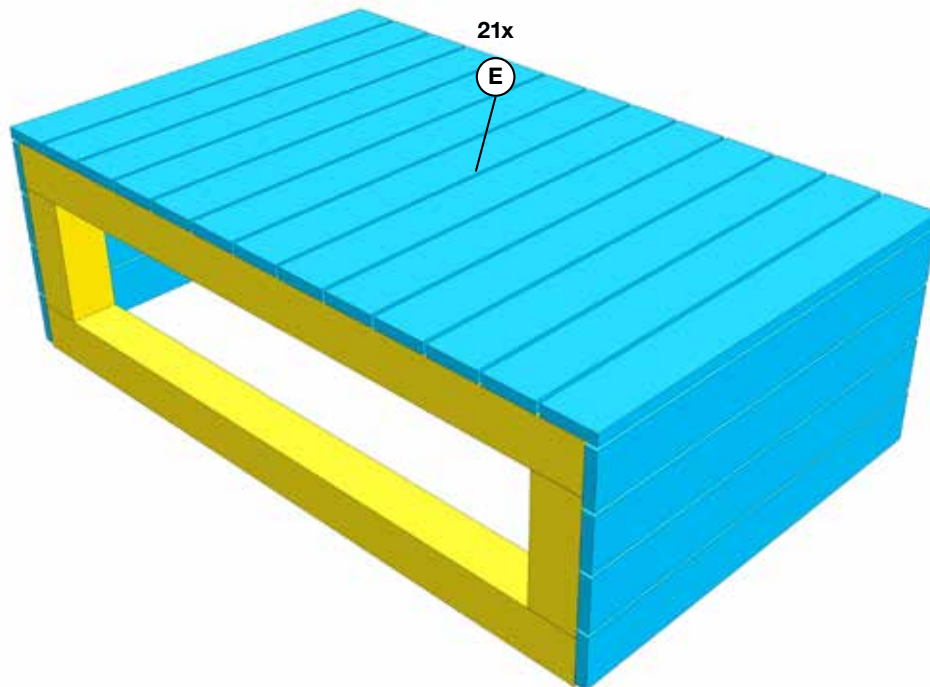

Table saw

SUPPLIES



2 1/2" screws



Patio Table

ASSEMBLY



SECTION 3: CLADDING

9



Flip the Assembly over so that the table is right-side-up. Place two Part (E) on the end of the table so they are adjacent. Butt up the top plank so it is flush with the adjacent piece. Hold this position in place.

10



With this piece overhung the correct amount, attach to the table frame assembly. Repeat this on the opposite end of the table, using the same process.

11



After the two end pieces are secured, lay out thirteen more Part (E)s evenly spaced, with their best face up. Take the average spacing distance to create a Spacer Jig. Rip a 2x4 to that thickness.

12



Next, starting at one end, check flush on each end of the slat and secure the slats to the Support Frame with 2 1/2" screws.

13



As you approach the other end, check that the Spacer Jig will be correct for the remaining distance. Adjust the spacing on the last few boards if needed. Then, secure planks to the middle support beams.

14



Once the top surface is complete, use the Spacer Jig to set the spacing for the first waterfall edge cladding. Check for flush, then secure with one screw on each end.

15



Attach the bottom plank using the same technique.

16



Finally, evenly space the two boards that fit in between and attach. Repeat on the other end of the table to complete the cladding.

COMPLETED SECTION

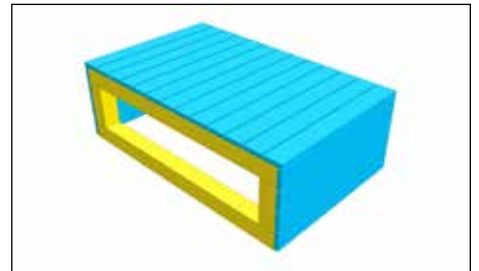

Patio Table

FINISHING

YellaWood®
Pressure Treated Pine

SECTION 4: FINISHING

SUPPLIES



YellaWood Protector®
Stain & Sealer

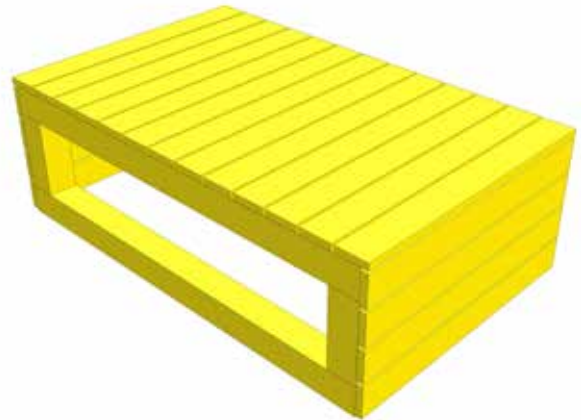

TOOLS



Radial sander
(or sanding block)



Paint/Stain Brush

YellaWood® brand products provide the best available pressure treated lumber protection against rot, fungal decay and termites. Sanding edges is recommended to reduce snags and splintering. At a minimum, we recommend annual application of a water repellent. You can also paint or stain it if you prefer.

17



Ease any sharp edges using a radial sander or sanding block with medium grit. Apply preferred finish to the wood.

18



We recommend long lasting YellaWood Protector® semi-transparent stain and water repellent wood sealer, the only stain backed by the famous Yella Tag. Follow manufacturer's recommendations for application.

CONGRATULATIONS. ENJOY YOUR NEW PATIO TABLE!

Patio Table // Hack

PROJECT PLAN

YellaWood
Pressure Treated Pine

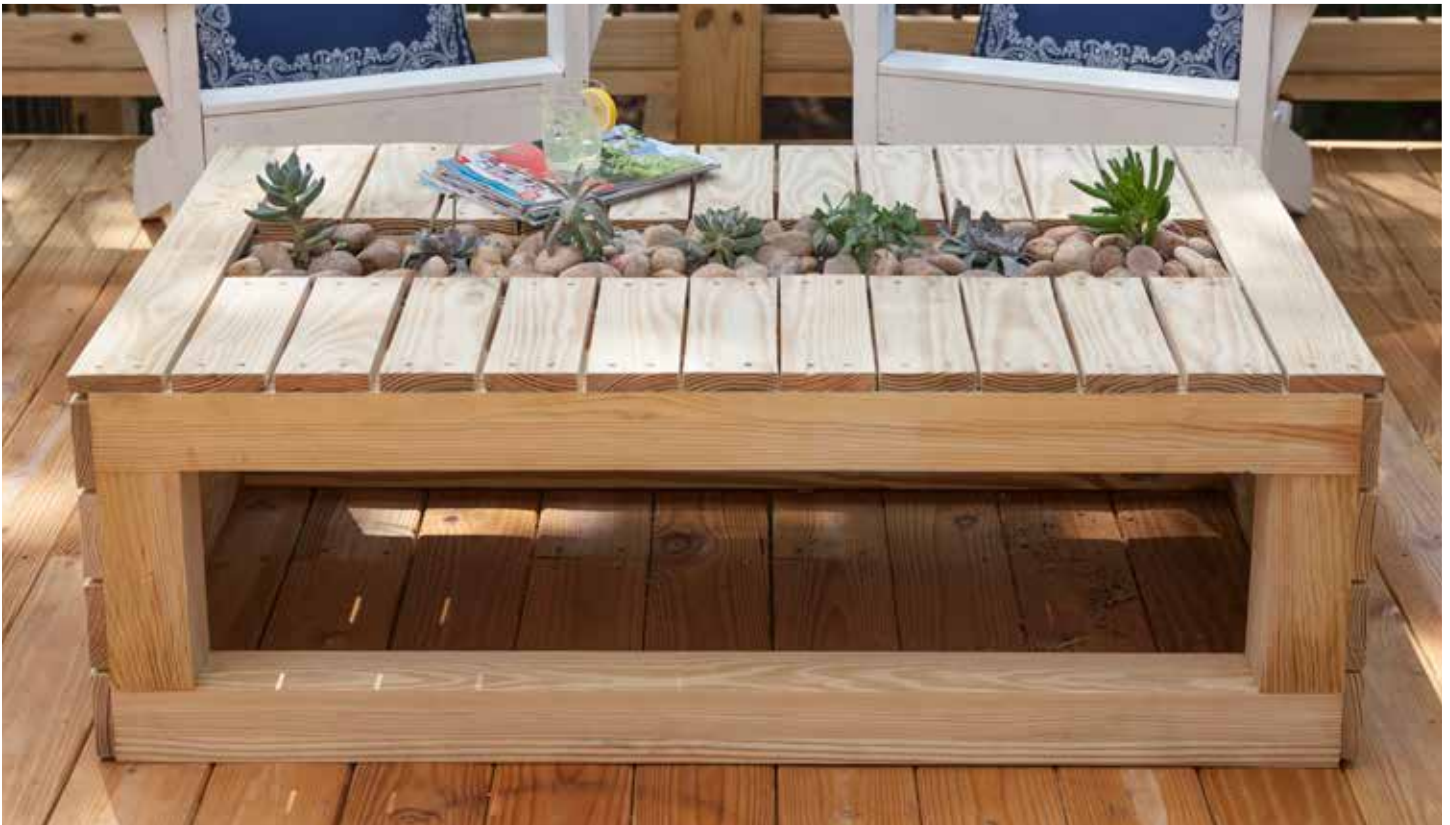

Add even more beauty to your backyard beautification.

A simple enhancement to this project can go a long way. This was designed to allow for a modification, or hack, if you desire.

By removing all but the outer top slats, the support structure will be visible. Then the table is flipped over and slats are cut and attached to form the base of the plant trough. After it's turned right-side-up, the existing slats are cut and attached to the top surface again but on either side of the trough.

Once this is complete, the trough is ready for a liner, soil, and the flora of your whimsy. Be it daisies, pansies, or succulents, this table upgrade adds visual and functional value to an already great patio table.

BUILD TIME

2
HRS

DIFFICULTY



COST



Patio Table // Hack

YellaWood
Pressure Treated Pine

OVERALL SIZE

TOP

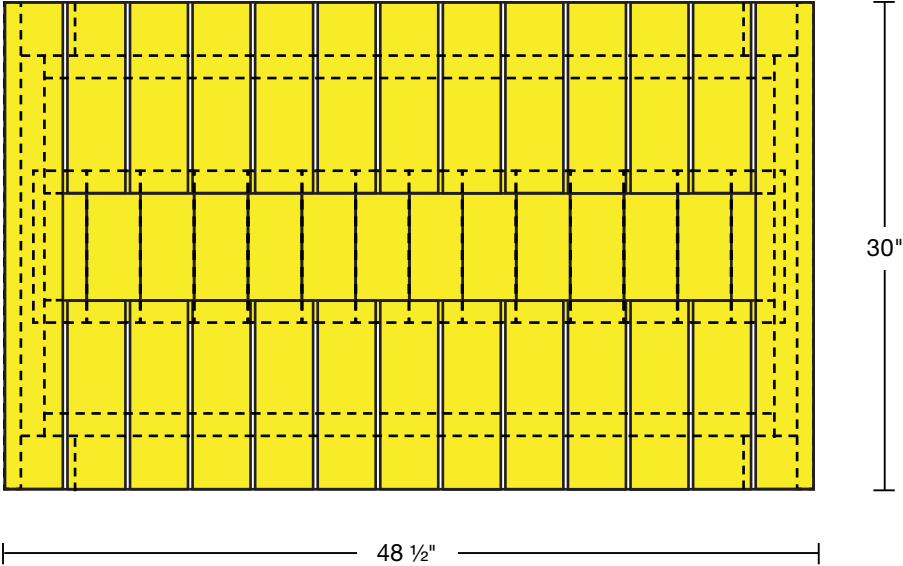

SIDE

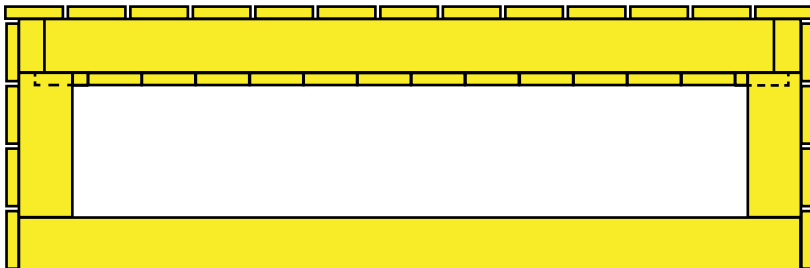

FRONT

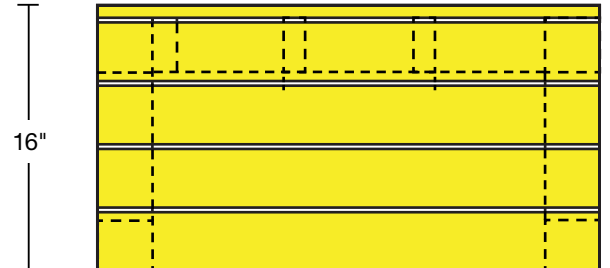

Patio Table // Hack

YellaWood
Pressure Treated Pine

OVERVIEW OF STEPS

SEQUENCE OF BUILD

1: REMOVE SLATS

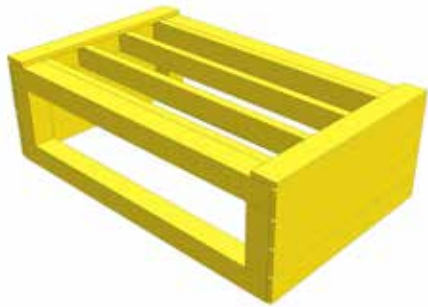

2: ATTACH TROUGH SLATS

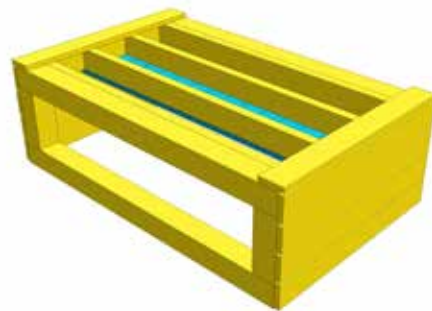

3: ATTACH TOP SLATS

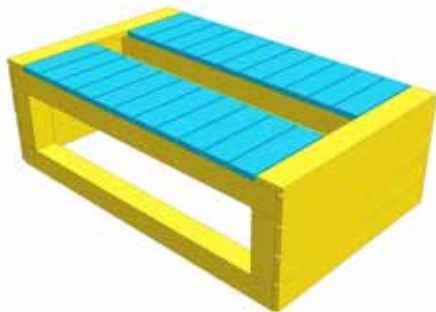

4: FINISHING

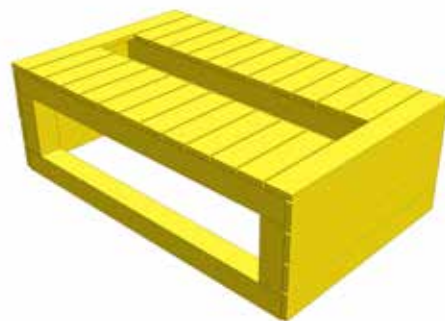

BUILD TIME

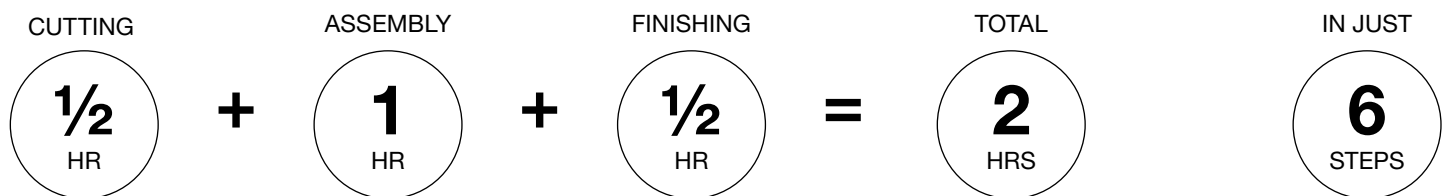

Patio Table // Hack

YellaWood®
Pressure Treated Pine

WHAT YOU'LL NEED

MATERIALS

- 2x** 1x4x10' YellaWood® pressure treated pine
- 1x** 2x4 Spacer Jig used in Step 11

HARDWARE

½ LB BOX

- 2 ½" wood screws + appropriate bit

WOOD FINISHING

- YellaWood Protector® Stain & Sealer

TOOLS



Pencil



Measuring tape



Miter saw
(or chop saw)



Combination
countersink bit
(with 2" long 1/8" bit)



Drill / driver



Radial sander
(or sanding block)



Damp cloth
(optional)



Waterproof
wood glue
(optional)



Paint/Stain
Brush

SAFETY EQUIPMENT

- Work gloves
- Dust mask
- Safety glasses
- Ear protection

Notes:

Consider using YellaWood® KDAT and higher grade products to achieve more professional results.

Patio Table // Hack

YellaWood
Pressure Treated Pine

ASSEMBLY

INSTRUCTIONS FOR ALL SECTIONS

1

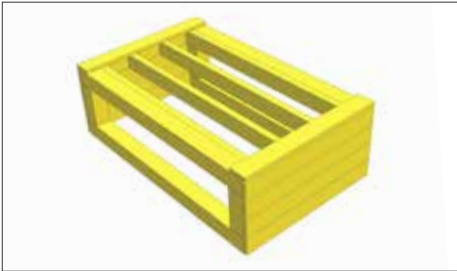

Begin by removing all but the outer two top slats on the existing Patio Table. Discard used screws.

2

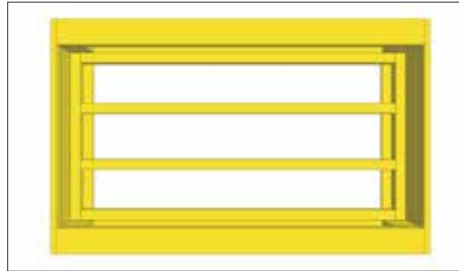

Flip table over, and cut eleven 1x4s to 13".

3

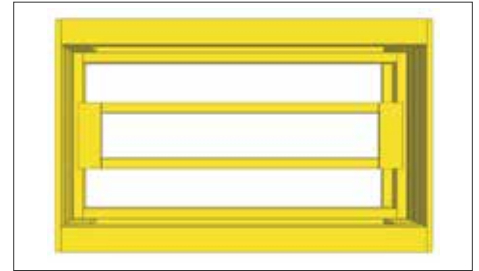

Attach one slat to the 2x4 support on either end of the trough using 2 1/2" screws. Evenly space the remaining boards in between. Use the Spacer Jig from Step 11 after cross-cutting it to 14".

4

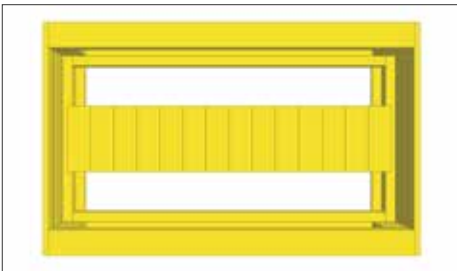

Continue attaching the slats using the Spacer Jig, noting if you need to expand to shrink the spacing as you get toward the end.

5

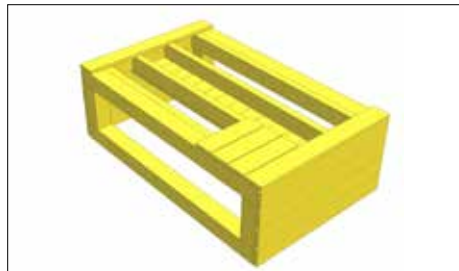

Flip table right-side-up and measure the distance from the edge of the table to the outside of the first inner 2x4 support. Cross-cut the boards that were removed to this new dimension.

6

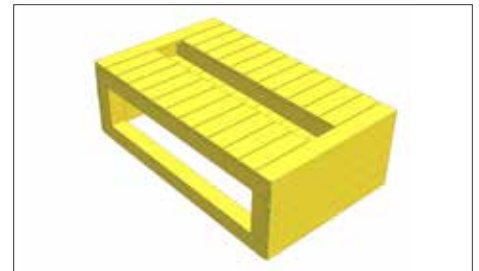

Using the existing hole pattern, re-attach the cladding onto the structure. Ease any sharp edges using a radial sander or sanding block with medium grit. Apply preferred finish to the wood.

CONGRATULATIONS. ENJOY YOUR NEW **UPGRADED** PATIO TABLE!

Patio Table // Hack

GALLERY OF IMAGES

YellaWood
Pressure Treated Pine



Patio Table

FASTENER & HARDWARE INFORMATION



FOR INTERIOR OR EXTERIOR APPLICATIONS

Use fasteners and hardware that are in compliance with the manufacturer's recommendations and the building codes for their intended use. As with any good design and construction practices, treated wood should not be used in applications where trapped moisture or water can occur. Where design and/or actual conditions allow for constant, repetitive or long periods of wet conditions, only stainless steel fasteners should be used.

FOR EXTERIOR APPLICATIONS

The following minimum galvanization levels may be used for connectors, joist hangers, fasteners and other hardware that are placed in direct contact with exterior applications of micronized copper treated wood:

- **Fasteners** – nails, screws, etc. ASTM – A 153 (1 oz/ft²)
- **Hardware** – connectors, joist hangers, etc. ASTM – A 653 G90 (0.90 oz/ft²)

The effects of other building materials within a given assembly, along with environmental factors, should also be considered when selecting the appropriate hardware and fasteners to use for a given project containing treated wood.

Stainless Steel fasteners and hardware are required for Permanent Wood Foundations below grade and are recommended for use with treated wood in other severe exterior applications such as swimming pools, salt water exposure, etc. Type 304 and 316 are recommended grades to use.

ALUMINUM

Aluminum building products may be placed in direct contact with YellaWood® brand products used for interior uses and above ground exterior applications such as decks, fencing, and landscaping projects. Examples of aluminum products include siding, roofing, gutters, door and window trim, flashing, nails, fasteners and other hardware connectors. However, direct contact of treated products and aluminum building products should be limited to code-compliant construction applications that provide proper water drainage and do not allow the wood to be exposed to standing water or water immersion.

We recommend you contact the aluminum building products manufacturer for its recommendations regarding use of its aluminum products in contact with treated wood in ground contact applications or when exposed to salt water, brackish water, or chlorinated water, such as swimming pools or hot tubs.

Also check with the aluminum building products manufacturer regarding compatibility with other chemicals and cleaning agents and the use of their aluminum products in commercial, industrial, and specialty applications such as boat construction.

YellaWood® brand pressure treated products are treated with preservatives (the "Preservatives") and preservative methods and technologies of unrelated third parties. For details regarding the Preservatives, methods, and technologies used by Great Southern Wood Preserving, Incorporated, see www.yellowood.com/preservative or write us at P.O. Box 610, Abbeville, AL 36310. Ask dealer for warranty details. For warranty or for important handling and other information concerning our products including the appropriate Safety Data Sheet (SDS), please visit us at www.yellowood.com/warranties or write us at P.O. Box 610, Abbeville, AL 36310. YellaWood®, YellaWood Protector® and the yellow tag are federally registered trademarks of Great Southern Wood Preserving, Incorporated.

Great Southern Wood Preserving, Incorporated makes no warranties expressed or implied as to the fitness for a particular purpose of this plan.

Patio Table

IMPORTANT INFORMATION



- Consult the end tag to determine which preservative or preservative system was used in the treatment of that particular product. YellaWood® brand products may be used in direct contact with aluminum building products when limited to code-compliant construction applications that provide proper water drainage and do not allow the wood to be exposed to standing water or water immersion.
- Use fasteners and other hardware that are in compliance with building codes for the intended use.
- Do not burn preserved wood.
- Wear a dust mask and goggles when cutting or sanding wood.
- Wear gloves when working with wood.
- Some preservative may migrate from the treated wood into soil/water or may dislodge from the treated wood surface upon contact with skin.
- Wash exposed skin areas thoroughly.
- All sawdust and construction debris should be cleaned up and disposed of after construction.
- Wash work clothes separately from other household clothing before reuse.
- Preserved wood should not be used where it may come into direct or indirect contact with drinking water, except for uses involving incidental contact such as fresh water docks and bridges.
- Do not use preserved wood under circumstances when the preservative may become a component of food, animal feed or beehives.
- Do not use preserved wood as mulch.
- Only preserved wood that is visibly clean and free of surface residue should be used. If the wood is to be used in an interior application and becomes wet during construction, it should be allowed to dry before being covered or enclosed.
- Mold growth can and does occur on the surface of many products, including untreated and treated wood, during prolonged surface exposure to excessive moisture conditions. To remove mold from the treated wood surface, wood should be allowed to dry. Typically, mild soap and water can be used to remove remaining surface mold. For more information visit www.epa.gov.
- Projects should be designed and installed in accordance with federal, state and local building codes and ordinances governing construction in your area, and in accordance with the National Design Specifications (NDS) and the Wood Handbook.

DISPOSAL RECOMMENDATIONS

Preserved wood may be disposed of in landfills or burned in commercial or industrial incinerators or boilers in accordance with federal, state and local regulations.